

RobLight



FL 1500 XT

User manual

RobLight

Introduction

The RobLight FL 1500 XT light generator is designed for outdoor use, with glass and PMMA fibre harness Ø28 mm. It can be used in all installations set-ups, including closed compartments if limits for max ambient temperature are followed.

FL 1500 XT is designed as replacement for FL 150 XT-series.

Product overview/unboxing

- 1 FL 1500 XT
- 1 User manual
- 1 Allen key

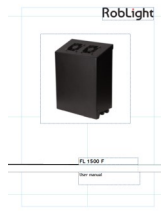

Installation instructions

Follow the installation instructions to ensure

- Safe operation
- Full functionality
- Stated expected lifetime
- Uninterrupted illumination

RobLight

Warning

This device has a built in high power phosphor converted blue led. The light source is grouped in Risk Group 2.

Risk group 2



CAUTION.
Possibly hazardous optical radiation emitted from this product. Do not stare at operating lamp. May be harmful to the eye.

Do not look into the light port when lit.

Beware of placing highly light absorbing material directly in front (Distance 0-1cm) of the port or a fibre. The extremely high intensity will increase the temperature in the material.

Using non RobLight harnesses in this light generator is at its own risk.

Ensure that the polyconnector is undamaged and clean before using the light generator in retrofit RobLight installations.

Beware that when the or a light generator is operated at max ambient temperature the surface temperature can exceed 75°C.

The light generator is only tested with RobLight standard polyconnector end.

Warranty label

The warranty label is not to be broken under ANY circumstances. If broken the warranty is terminated.

RobLight

Technical data

General

| | |
|------------------------|--------------------------|
| Light port | Ø28 mm |
| Fibre type | PMMA or glass |
| Material | Aluminium, POM and other |
| Dimensions (L x H x W) | 375 x 170 x 300 mm |
| Weight (total) | 8600 g |
| Safety | CE |

Environmental

| | |
|---------------------|-----------------|
| Protection rating | IP 45 |
| Thermal protection | Integrated auto |
| Cooling | Axial fan x 2 |
| Ambient temperature | -10° to 45° C |

Driver/electrical

| | |
|---------------------------|------------------------------------|
| Driver | Inventronics |
| Supply voltage (mains) | 100-240V 50/60Hz |
| Driver expected lifetime | 100.000 hours (@TC = 65° C) |
| Total power consumption | 130 W (C-DMX), 115 W (white light) |
| Fan expected lifetime | 40.000 hours |
| Fan sound level | 30dB (A) |
| Dimmer systems applicable | Pot, DMX depended on the model |

Light source

| | |
|----------------------------------|-----------------------------------|
| Applied LED | Nichia |
| LED expected lifetime | >35.000 hours @Ta = 45° C |
| Typical CCT | 3000K or 4000K (5000K on request) |
| Typical Ra (CRI ₁₋₈) | 90+ |

RobLight

Installation instructions

- a) Remove cap from the light port
- b) Check that the end face of the polyconnector is clean and undamaged
- c) Insert the poly connector fully in the light port
- d) Tighten the screw onto the light port with an Allen key
- e) Ensure all installation and ventilation requirements are met
- f) Connect the supply cord to the mains

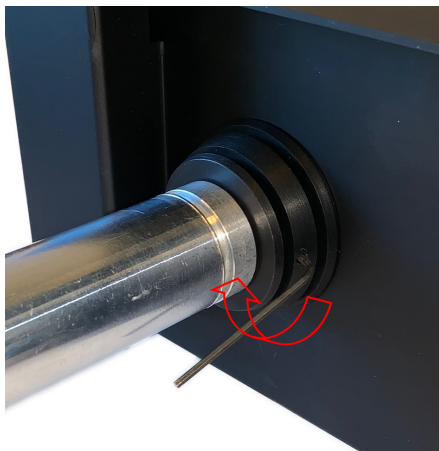
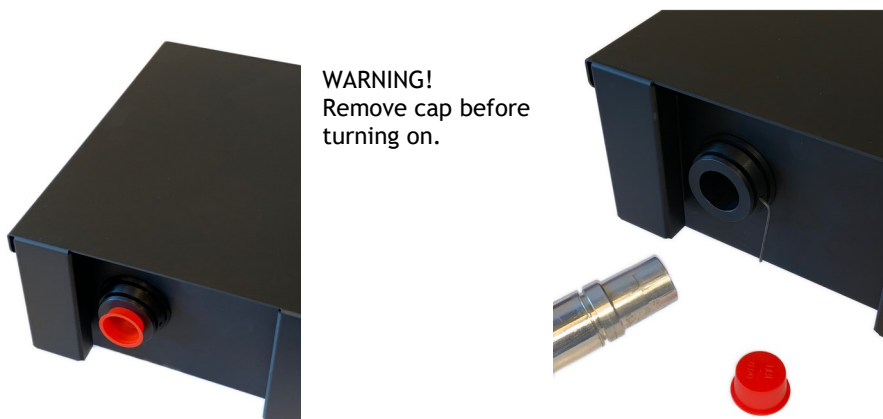

RobLight

Vertical mounting XT models

This light generator should not be mounted with light port upwards. At high ambient temperature the operational lifetime of the internal components and harness will be reduced.

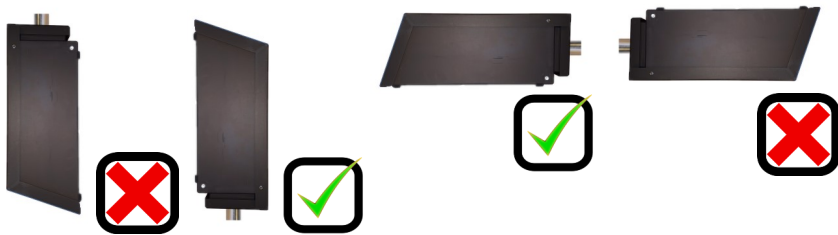

Mounting

Attach to surface using three screws in the baseplate holes. Be aware that the total weight of this system is more than 8.6 kg + the downforce from the fibre harness.

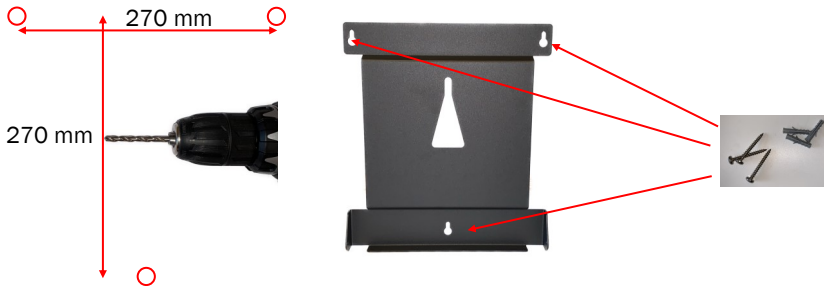

Drill 3 x $\varnothing 6$ mm holes.

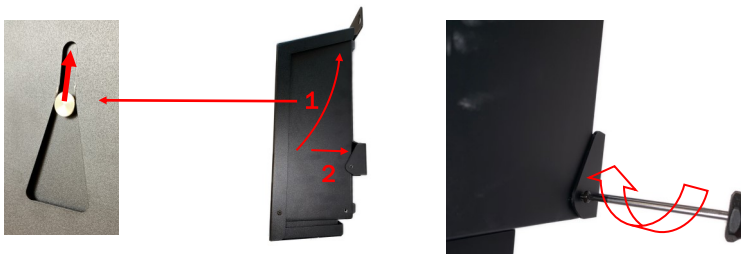

Closed compartments

MAX AMBIENT TEMPERATURE 45°C.

Recommendations: (should always be tested in a mock up)

Secure enough space to allow natural heat transmission through surfaces.

Surfaces should not be insulated.

Cooling air for the polyconnector can not be obstructed in any way, as it is essential to avoid damage to the harness.

General minimum distance from the light generator to any enclosing surface 15 cm (excluded mounting surface).

Beware of inlet and outlet ventilation holes opposite each other as shown on the drawing.

Keep free from dust and polluted air.

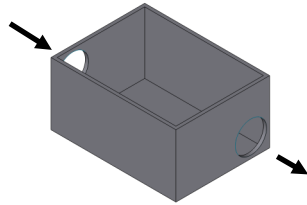

Installing adjacent light generators

Recommendation:

Minimum 30 cm distance between adjacent light generators to ensure enough free cooling air.

If multiple rows, use offset to avoid vertical rows. Minimal free distance between rows 40 cm.

Max temperature has to be observed for all light generators measured at air inlet for each light generator.

MAX AMBIENT TEMPERATURE 45°C.

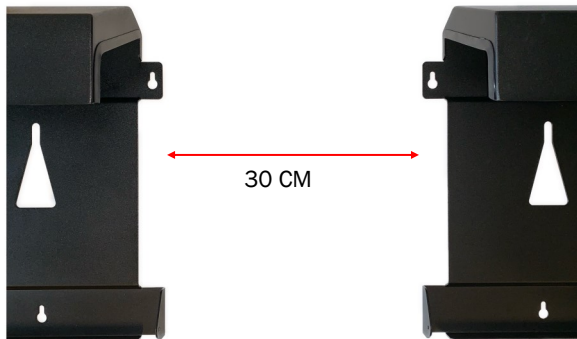

Accessories / Spare part

| | Part name | Description | Item no. |
|---|--------------------------|--|-----------|
|  | Adapter Ø28/Ø9 | To change the light port from Ø28 to Ø9 mm | 7800 0130 |
|  | Fan replacement kit | Repair kit with parts to install new fan | 0130 8000 |
|  | Mounting kit | Mounting plate for C and F models | 0136 9001 |
| | DMX control manual | | 9908 2152 |
|  | CTC filter-1000K Ø28 | | 0126 1019 |
|  | CTC filter -1200K Ø28 | | 0126 1020 |
|  | CTC filter -900K Ø28 | | 0126 1021 |
|  | CTC filter +2000K Ø28 | | 0126 1022 |
|  | CTC filter +1000K Ø28 | | 0126 1023 |
|  | FL 1500 XT filter holder | | 4900 1530 |

RobLight

Installing accessories

1. Remove the connector (3 screws)
2. Mount the filtre in the bracket
3. place the filter bracket on the back side of the connector
4. Replace the connector in the light generator

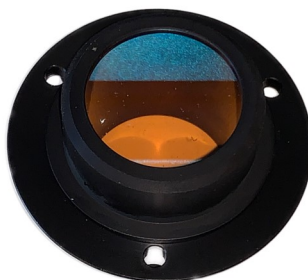
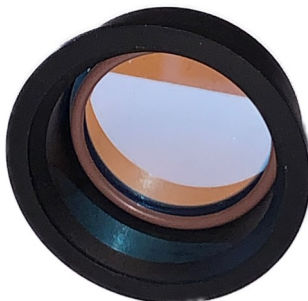
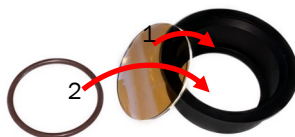

RobLight

Application notes

The light generator is an electronic device and must be handled accordingly. The different components will have different factors influencing the practical lifetime. The most important factor for this system is the condition of the surrounding air (temperature and cleanliness). The data we have stated about or and the expected lifetime of the key components, are at the temperatures that the suppliers have performed during their standardized tests in clean environments.

The light generator is designed to run at max ambient temperature, but the longest usable operation is achieved with lower temperatures.

Although there is thermal protection built into this device, it is only a safety device and should not be used as a measurement device to test if the light generator is running at a tolerable surrounding temperature.

The polyconnector is the most stressed part of this system. Care should be taken to ensure that the fibre ends are 100% clean and free from dust and grease (fingerprint will do damage.). See www.rob-light.com for recommendations to clean fibre ends.

Running the light generator at too high temperatures will not only risk damage to the light source but also to the fibre harness.

KEEP COOL

CLEAN AIR

Maintenance, spare parts and repairs

The effectiveness of the active cooling device is greatly diminished if the cooling fins and the air intake is blocked or polluted with dust. This will reduce the expected lifetime of the product.

The dust must be removed on a regular basis. Interval depending on the environment.

A fine brush, vacuum cleaning or light compressed air can be used for the cleaning.

This light source is not supposed to be otherwise serviced, if used as recommended.

The fan can be replaced using standard tools. A replacement kit with guide is available.

If the product is not performing as specified, use the troubleshooting guide. If you need further assistance, please contact RobLight.

Troubleshooting

| Problem | Trace the problem | Solution |
|---------------------------|---|---|
| No light | Check the power | Connect the power cord properly Turn on the device |
| | Check the temperature | Check if it is installed according to the instructions |
| | Check the dimming | Unplug the light generator. Unplug the dimmer system from the driver. Turn on the power |
| Light switches on and off | Check the operating conditions of the light generator | Check if it is installed according to the instructions |
| | Check the active cooling system | Remove dirt and dust from the light generator |

If problems are not solved using this guide, please contact RobLight A/S.

RobLight

RobLight

RobLight A/S, Gl. Skagensvej 105 H, DK-9900 Frederikshavn
T: +45 9244 4888, E: info@rob-light.com
www.rob-light.com

RobLight accepts no responsibility for possible errors in catalogues, brochures and other printed material.
RobLight reserves the right to alter or discontinue its products without notice. © 2019 RobLight A/S